

Standard Railing Styles



PINECONE

DECKS & CONSTRUCTION

— 219-201-0162 —

Standard Railing with Square Balusters

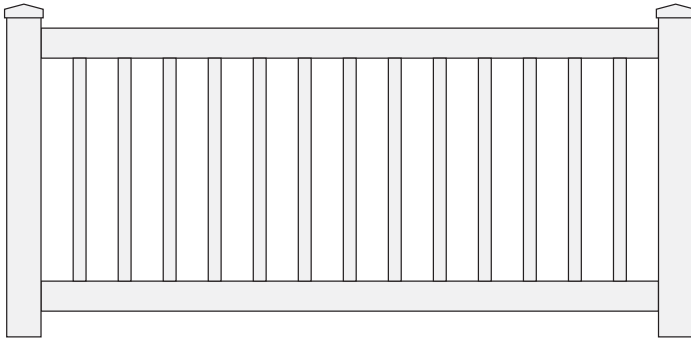

Standard Railing with Round Black Aluminum Balusters

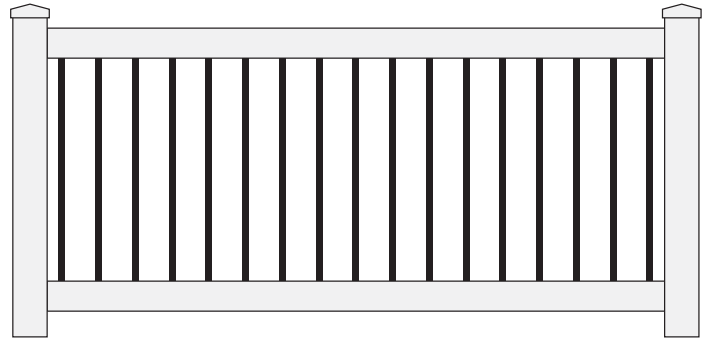

Standard Railing with "Colonial / Turned" Style Spindles

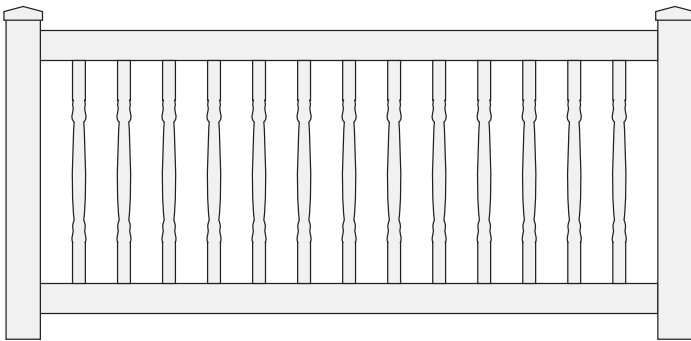

"Chippendale" Style Railing, *White Only*

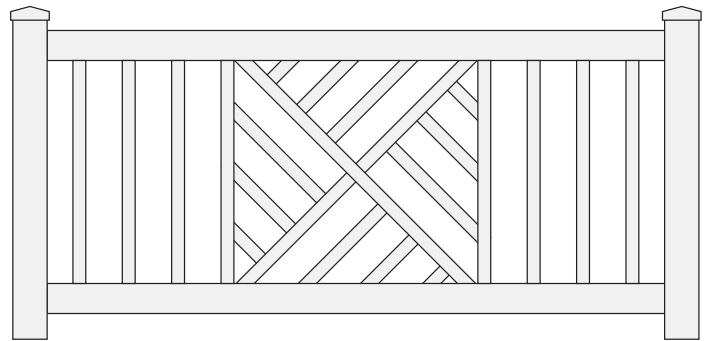

"Freeport" Style Railing, *White Only*

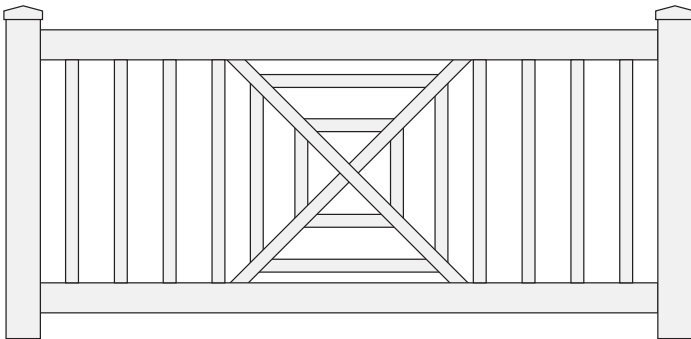

"Cheshire" Style Railing, *White Only*, 42" high Only

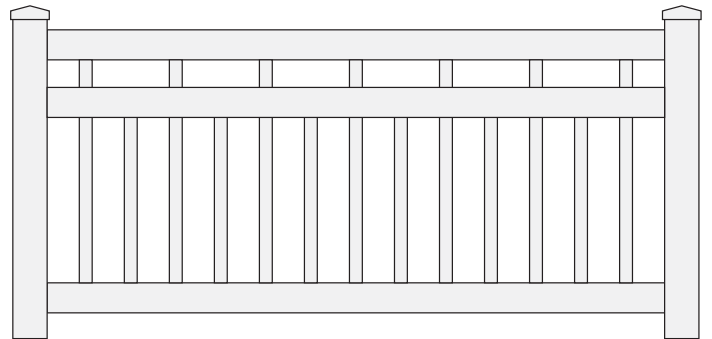

Specialty Railing Styles

“Boardwalk” Screen Panel (Black, white, or gray)

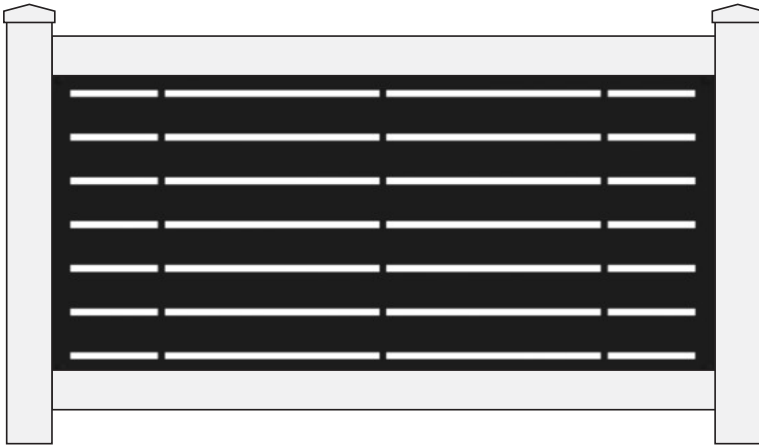

“Optic” Screen Panel (Black only)

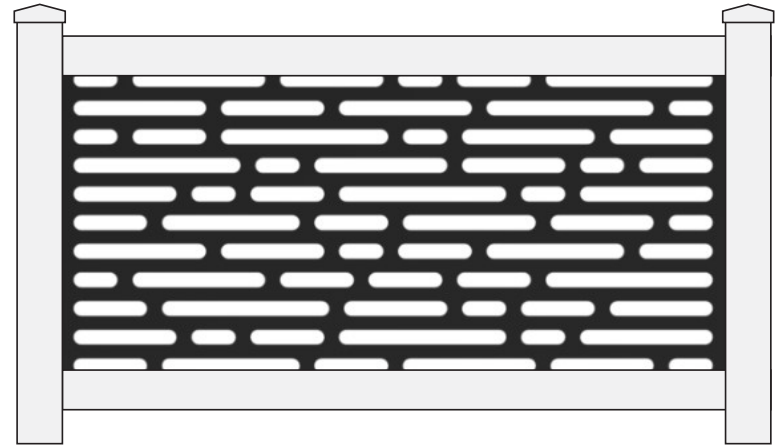

“Sanibel” Screen Panel (Black only)

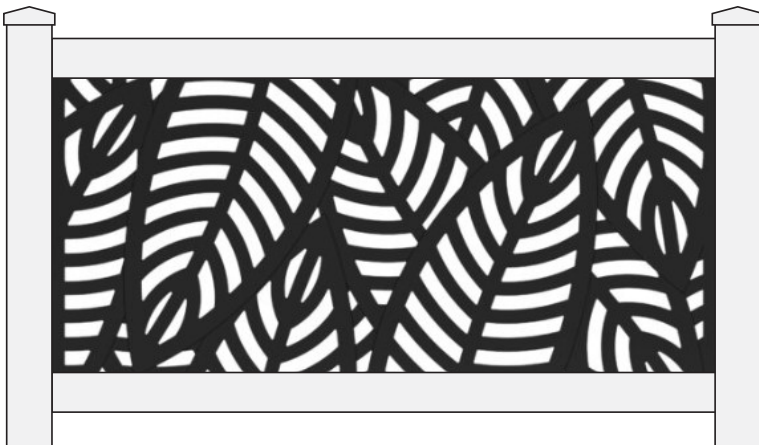

“River Rock” Screen Panel (Black only)

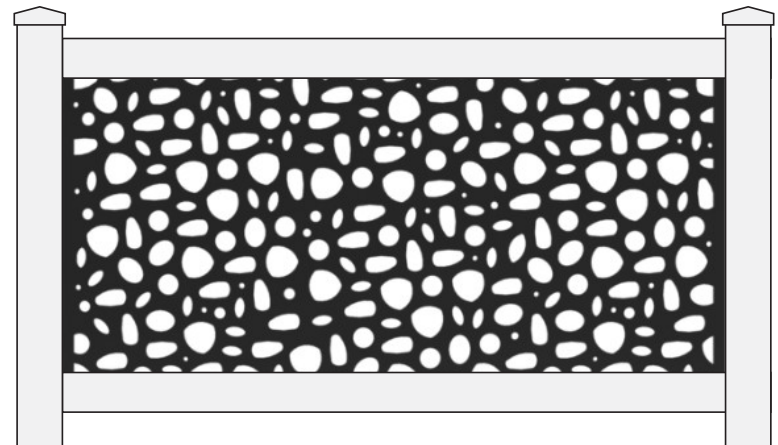

Top & Bottom Rail Details

T-shaped
top rail

Aluminum insert
in top and
bottom rail



*Not shown: 2" by 3.5"
rectangular bottom rail

Color Options

*Specialty colors, limited availability

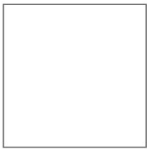

White

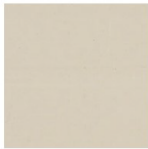

Sand/Tan

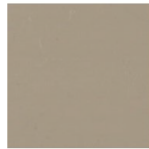

Clay/Adobe



Coastal Cedar

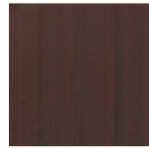

Dark Sequoia

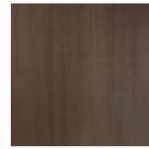

Dark Walnut



Driftwood



Weathered
Aspen

Post Cap Options

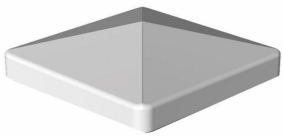

flat/standard

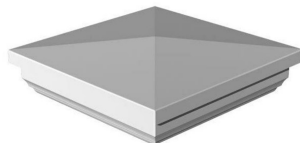

New England

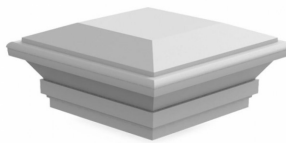

Contemporary



French Gothic



Ball

Mix & Match Color Options

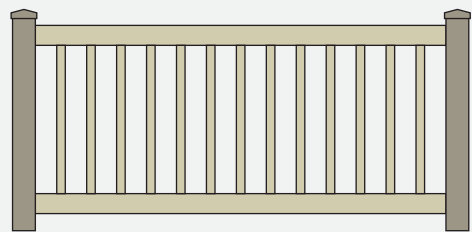
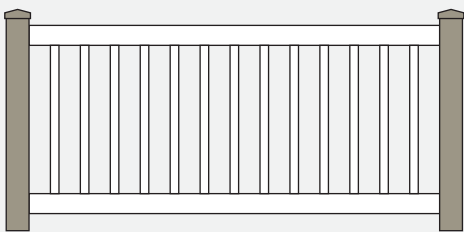
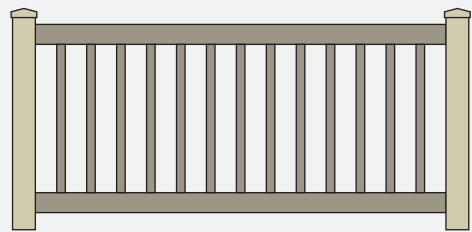
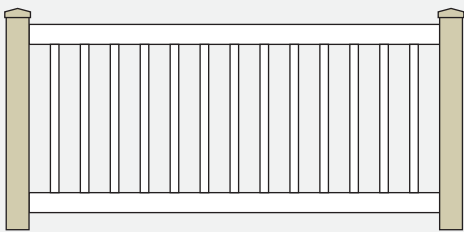
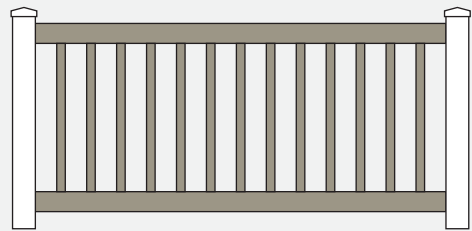
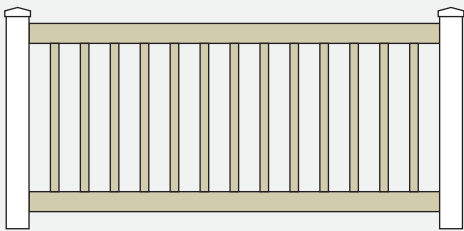
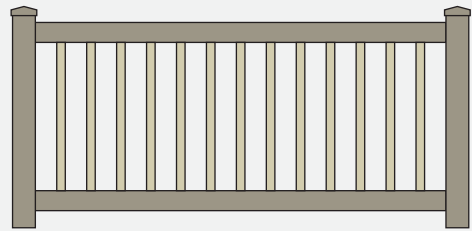
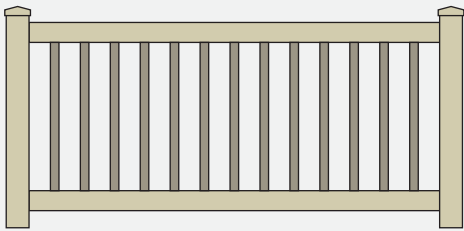
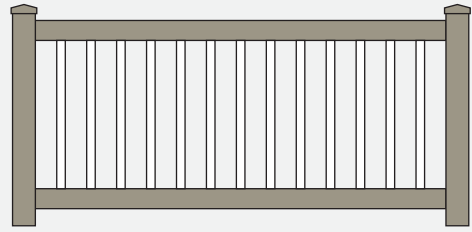
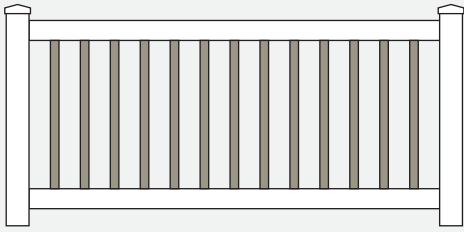
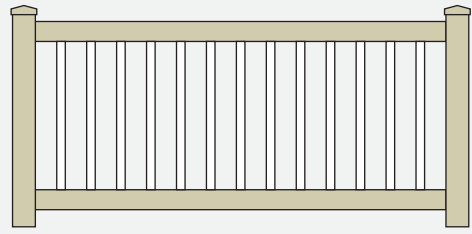
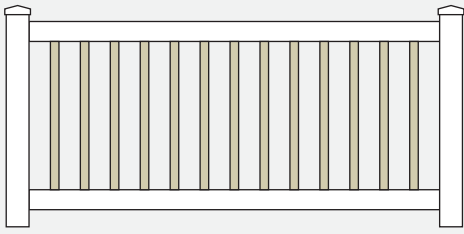

Specialty Black Vinyl Railing by



SUPERIOR[™]
OUTDOOR PRODUCTS

Black vinyl railings are newer to the market and manufactured in the USA by Superior Outdoor Products. The premium railings have a distinct moulded top rail and are engineered with UV inhibitors to resist fading and warping. Metal stiffeners are included in both top and bottom rails for added strength and to reduce the potential for sagging.

